

Dress

Design: Franca Lucarelli - Bruna Rapisarda

Tecnologia, mix di materia, forma lineare,
indiscutibilmente nato per arredare.

*Technology, mix of materials, and linear shape are
unquestionably created to decorate.*





L 1800 mm
H 400 mm
Z 175 mm

 pg 98



Dress







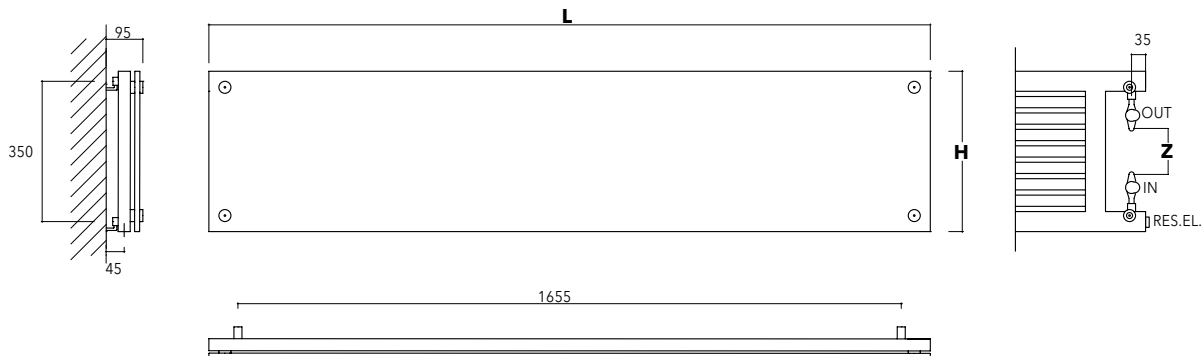

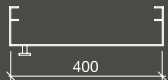

Design: Franca Lucarelli - Bruna Rapisarda

	IT	UK	FR	ES	DE
	- Acciaio e lastra in vetro temprato colorato - Acciaio e lastra specchio inox lucido	- Steel and tempered stained glass sheet - Steel and polished, stainless mirror sheet	- Acier et plaque en verre trempé coloré - Acier et plaque miroir en acier inox brillant	- Acero y placa de vidrio templado coloreado - Acero y placa espejo de acero inoxidable brillante	- Stahl und Platte aus vorgespanntem Buntglas - Stahl und Spiegelplatte aus glänzendem Nirostahl
	- Radiatore completo di vetro o specchio inox - Staffe a parete - Valvola e detentore - Valvola di sfriato	- Radiator complete with glass and stainless mirror - Wall brackets - Valve and holder - Exhaust valve	- Radiateur équipé de lace ou miroir inox - Supports muraux - Soupape et détenteur - Soupape de décompression	- Radiador con vidrio o espejo de acero inoxidable - Soportes de pared - Válvula y llave de cierre - Purgador	- Mit Glas und Nirostahlspiegel versehener Heizkörper - Wandhalterungen - Ventil und Drossel - Entlüftungsventil
	- Spalle radiatore: • Lucido - Lastra vetro temprato spessore 8 mm: • Bianco • Nero • Arancio • Rosso • Acquamarina - Lastra specchio: • Inox lucido	- Radiator supports: • Polished - Tempered glass sheet 8 mm thickness: • White • Black • Orange • Red • Aquamarine - Mirror sheet: • Polished, stainless	- Épaules radiateur: • Polies - Plaque de verre trempé épaisseur 8 mm: • Blanc • Noir • Orange • Rouge • Aigue-marine - Plaque miroir: • Inox brillant	- Laterales radiador: • Brillante - Placa de vidrio templado 8 mm espesor: • Blanco • Negro • Naranja • Rojo • Aquamarina - Placa espejo: • Acero inoxidable brillante	- Heizkörperschultern: • Glänzend - Vorgespannte Glasplatte, Dicke 8 mm: • Weiß • Schwarz • Orange • Rot • Aquamarinblau - Spiegelplatte: • Glänzender Nirostahl
	- Fornito con resistenza elettrica completa di cavo e spina Schuko. Installabile solo a destra	- Furnished with electrical heating element complete with cable and Schuko plug. Installed only on the right	- Fourni avec resistance électrique standard en classe II avec câble électrique et prise Schuko. Installé uniquement sur le droit	- Se suministra con resistencia eléctrica, con cable y enchufe Schuko. Instalado sólo a la derecha	- Mit elektrischem Widerstand, komplett mit Kabel und Schukostecker. Nur rechts installierbar
	- Fornito con resistenza elettrica completa di cavo e spina Schuko, installabile solo a destra, valvola e detentore	- Furnished with electrical heating element complete with cable and Schuko plug, installed only on the right, valve and holder	- Fourni avec résistance électrique standard en classe II avec câble électrique et prise Schuko, installé uniquement sur le droit, soupape et détenteur	- Se suministra con resistencia eléctrica, con cable y enchufe Schuko, instalado sólo a la derecha, válvula y llave de cierre	- Mit elektrischem Widerstand, komplett mit Kabel und Schukostecker, nur rechts installierbar, ventil und drossel
	- Valvola, detentore e attacchi idraulici interni al radiatore, mascherati dalla lastra - Pressione massima di esercizio: 5 bar - Non disponibile per impianti monotubo	- Valve, holder and hydraulic joints inside the radiator, hidden by the sheet - Maximum working pressure: 5 bar - Not available for single tube installation	- Soupape, détenteur, raccords hydrauliques à l'intérieur du radiateur, cachés par la plaque - Pression maximale de service: 5 bar - Non disponible pour installations monotube	- Válvula, llave de cierre y conexiones hidráulicas en el interior del radiador, camufladas por la plancha - Presión máxima de trabajo: 5 bar - No disponible para instalaciones monotubo	- Ventil, Halter und Hydraulikanschlüsse liegen heizkörperintern und sind durch die platte nicht sichtbar - Maximaler Betriebsdruck: 5 bar - Nicht für Einrohr-Anlagen verfügbar



ART.	RESE TERMICHE - THERMAL OUTPUT UNI EN 442 (ΔT 50 K)								IDRAULICO HYDRAULIC	ELETTRICO ELETTRIC	MISTO MIXED
	L	H	Z	W	Lt	Kg	Watt	LASTRA DI COPERTURA COVER SHEET			
DRESS 18X40 V	1800	400	175	680	10,2	29,5	600	Vetro Glass	€ 1678,00	€ 1818,00	€ 1798,00
DRESS 18X40 S	1800	400	175	850	10,2	31,5	600	Inox Stainless	€ 2135,00	€ 2275,00	€ 2255,00

a	<p>PORTA ASCIUGAMANO</p>  <p>400</p> <p>chromo PSD € 86,00</p>	<p>TOWEL HOLDER</p>  <p>400</p> <p>chrome PSD € 86,00</p>	<p>PORTE-SERVIETTES</p>  <p>400</p> <p>chrome PSD € 86,00</p>	<p>TOALLERO</p>  <p>400</p> <p>chromo PSD € 86,00</p>	<p>HANDTUCHHALTER</p>  <p>400</p> <p>chrom PSD € 86,00</p>
	<p>PORTA ASCIUGAMANO CON PORTA ACCAPPATOIO</p>  <p>400</p> <p>chromo PSAD € 120,00</p>	<p>TOWEL WITH ROBE HOLDER</p>  <p>400</p> <p>chrome PSAD € 120,00</p>	<p>PORTE-SERVIETTES AVEC PORTEMANTEAU</p>  <p>400</p> <p>chrome PSAD € 120,00</p>	<p>TOALLERO CON PORTA-ALBORNOZ</p>  <p>400</p> <p>chromo PSAD € 120,00</p>	<p>HANDTUCHHALTER MIT BADEMANTELHALTER</p>  <p>400</p> <p>chrom PSAD € 120,00</p>

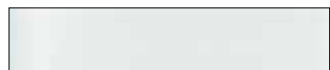

Vetro bianco - White glass

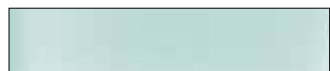

Vetro acquamarina - Aquamarine glass



Vetro arancio - Orange glass



Vetro rosso - Red glass



Vetro nero - Black glass



Specchio inox lucido
Polished stainless mirror

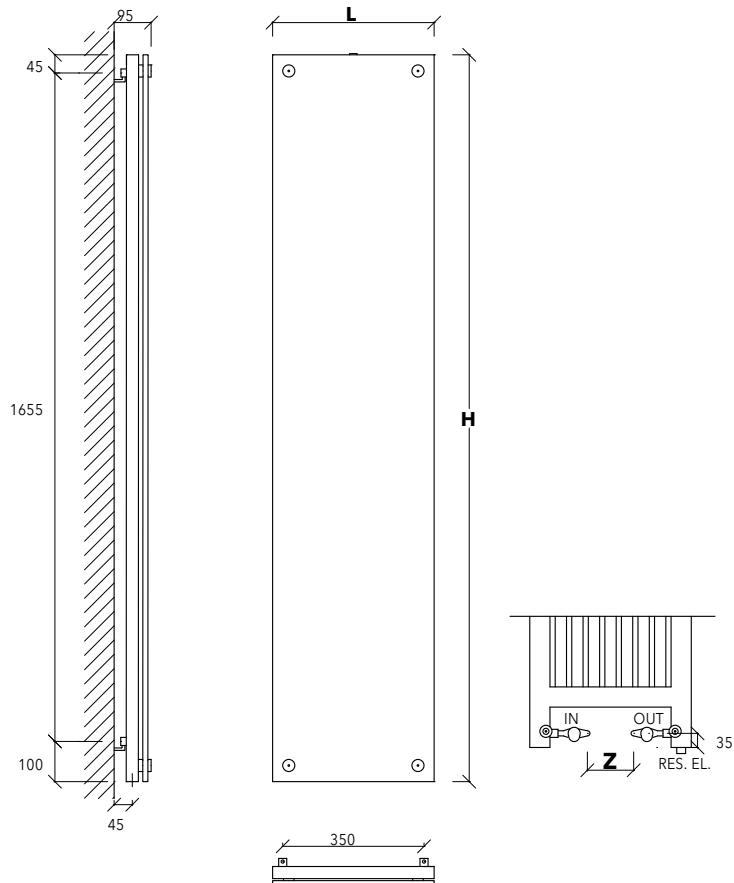

		RESE TERMICHE - THERMAL OUTPUT UNI EN 442 (ΔT 50 K)							Watt = Kcal/h ÷ 0,860 Kcal/h = Watt x 0,860	IDRAULICO HYDRAULIC	ELETTRICO ELETTRIC	MISTO MIXED
ART.	DIMENSIONI DIMENSIONS			RESA OUTPUT	CAPACITÀ CAPACITY	PESO WEIGHT	RESISTENZA RESISTANCE	LASTRA DI COPERTURA COVER SHEET	€	€	€	
	L	H	Z	W	Lt	Kg	Watt					
DRESS 18X40 V	400	1800	175	680	10,2	29,5	600	Vetro Glass	1678,00	1818,00	1798,00	
DRESS 18X40 S	400	1800	175	850	10,2	31,5	600	Inox Stainless	2135,00	2275,00	2255,00	