

Snake

Design: Franca Lucarelli - Bruna Rapisarda

Una collezione dal segno grafico deciso.
Forma, materia, funzione e tecnologia creano non
più semplici scaldasalviette ma veri e propri elementi
d'arredo.

*A collection with a firm graphic sign. Shape, material,
function, and technology, no longer simple heated
towel rail, but real pieces of decoration.*



Snake 66

H 600 mm

L 660 mm

 pg 90





Snake 85

H 450 mm
L 850 mm

 pg 90



Snake 50

H 710 mm
L 500 mm

 pg 90





Snake One





H 1730 mm
L 500 mm

 pg 91



Snake

Design: Franca Lucarelli - Bruna Rapisarda

	IT	UK	FR	ES	DE
	- Acciaio - Acciaio inox	- Steel - Stainless steel	- Acier - Acier inox	- Acero - Acero inoxidable	- Stahl - Inox-Stahl
	- Staffe a parete - Valvola e detentore - Valvola di sfogo - Kit copritubo	- Wall brackets - Valve and holder - Exhaust valve - Tube cover kit	- Supports muraux - Soupape et détenteur - Soupape de décompression - Kit cache-tube	- Soportes de pared - Válvula y llave de cierre - Purgador - Kit de cobertura tubo	- Wandhalterungen - Ventil und Drossel - Entlüftungsventil - Rohrverkleidungssatz
	- Acciaio: • Cromo • Gamma colori Scirocco H, pg 8/9 - Acciaio inox: • Spazzolato	- Steel: • Chrome • Colour chart Scirocco H, pg 8/9 - Stainless steel: • Brushed	- Acier: • Chrome • Gamme couleurs Scirocco H, pg 8/9 - Acier inox: • Brossé	- Acero: • Cromo • Gama de colores Scirocco H, pg 8/9 - Acero inoxidable: • Cepillado	- Stahl: • Chrom • Farbpalette von Scirocco H, pg 8/9 - Inox-Stahl: • Gebürstet
	- Attacchi: 3/8" G - Pressione massima d'esercizio: 5 bar - Ogni articolo viene fornito con dima per interesse valvole e posizione fissaggi a muro - Non disponibile per impianti monotubo	- Connections: 3/8" G - Maximum working pressure: 5 bar - Each item is supplied with a template for the centre distance between the valves and the position for wall fixing - Not available for single tube installation	- Connection: 3/8" G - Pression maximale de service: 5 bar - Chaque article est livré avec un gabarit pour entreaxe de soupapes et position de fixations murales - Non disponible pour installations monotube	- Conexiones: 3/8" G - Presión máxima de trabajo: 5 bar - Todos los artículos se suministran con plantilla para calcular la distancia entre ejes de las válvulas y la posición de los elementos de fijación a la pared. - No disponible para instalaciones monotubo	- Anschlüsse: 3/8" G - Maximaler Betriebsdruck: 5 bar - Jeder Artikel wird mit einer Schablone zur Bestimmung des Ventilabstands und der Wandbefestigungen geliefert - Nicht für Einrohr-Anlagen verfügbar

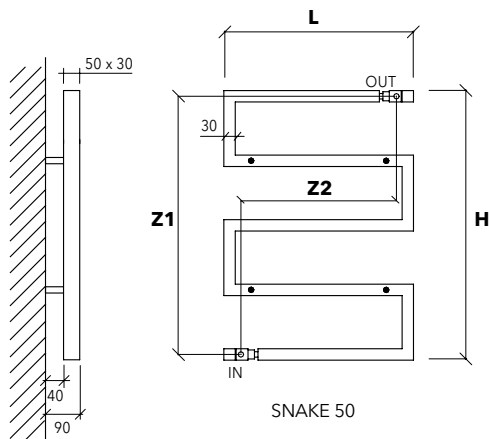

SNAKE 50

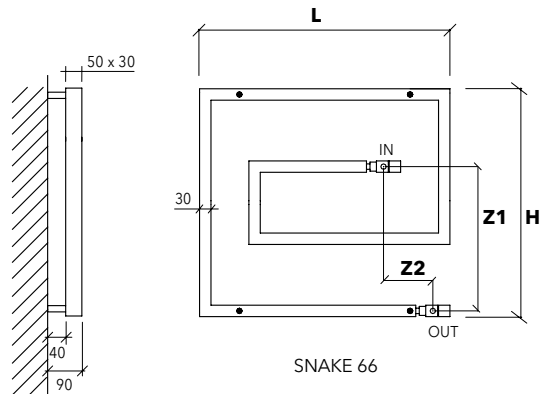

SNAKE 66

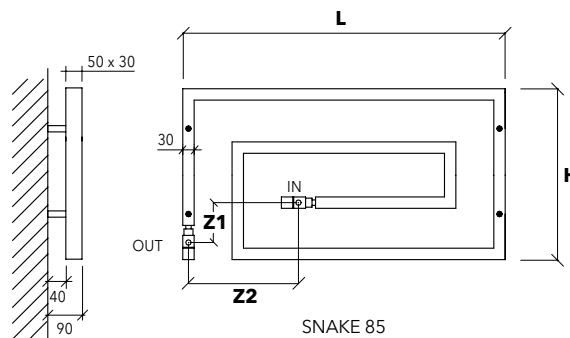

SNAKE 85

RESE TERMICHE - THERMAL OUTPUT
UNI EN 442 (ΔT 50 K)

Watt = Kcal/h \times 0,860
Kcal/h = Watt \times 0,860





IDRAULICO
HYDRAULIC





ART.	DIMENSIONI DIMENSIONS				RESA OUTPUT	RESA CROMO OUTPUT CHROME	CAPACITÀ CAPACITY	PESO WEIGHT	COLORE COLOUR	CROMO CHROME	INOX SPAZZOLATO BRUSHED STAINLESS STEEL
	L	H	Z1	Z2	W	W	Lt	Kg	€	€	€
SNAKE 50	500	710	680	410	285	230	5,0	6,6	880,00	999,00	1058,00
SNAKE 66	660	600	380	130	290	235	5,4	7,1	880,00	999,00	1058,00
SNAKE 85	850	450	110	290	305	245	6,2	8,2	880,00	999,00	1058,00

Snake One

Design: Franca Lucarelli - Bruna Rapisarda

	IT	UK	FR	ES	DE
	- Acciaio	- Steel	- Acier	- Acero	- Stahl
	- Staffe a parete - Valvola e detentore - Valvola di sfianto - Kit copritubo	- Wall brackets - Valve and holder - Exhaust valve - Tube cover kit	- Supports muraux - Soupape et détenteur - Soupape de décompression - Kit cache-tube	- Soportes de pared - Válvula y llave de cierre - Purgador - Kit de cobertura tubo	- Wandhalterungen - Ventil und Drossel - Entlüftungsventil - Rohrverkleidungssatz
	- Cromo - Gamma colori Scirocco H, pg 8/9	- Chrome - Colour chart Scirocco H, pg 8/9	- Chrome - Gamme couleurs Scirocco H, pg 8/9	- Cromo - Gama de colores Scirocco H, pg 8/9	- Chrom - Farbpalette von Scirocco H, pg 8/9
	- Attacchi: 3/8" G - Pressione massima d'esercizio: 5 bar - Non disponibile per impianti monotubo	- Connections: 3/8" G - Maximum working pressure: 5 bar - Not available for single tube installation	- Connection: 3/8" G - Pression maximale de service: 5 bar - Non disponible en cas	- Conexiones: 3/8" G - Presión máxima de trabajo: 5 bar - No disponible para instalaciones monotubo	- Anschlüsse: 3/8" G - Maximaler Betriebsdruck: 5 bar - Nicht für Einrohr-Anlagen verfügbar

	PORTA ACCAPPATOIO	ROBE HOLDER	PORTEMANTEAU	PORTA-ALBORNOZ	BADEMANTELHALTER
	 colore PAS € 33,00 cromo PAS € 48,00	 colour PAS € 33,00 chrome PAS € 48,00	 couleur PAS € 33,00 chrome PAS € 48,00	 color PAS € 33,00 cromo PAS € 48,00	 farbe PAS € 33,00 chrom PAS € 48,00

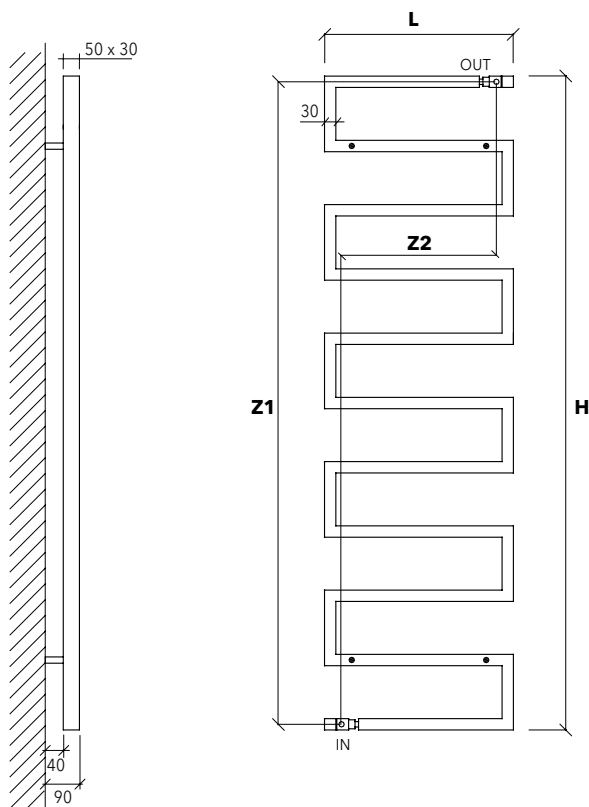

RESE TERMICHE - THERMAL OUTPUT
UNI EN 442 (ΔT 50 K)

Watt = Kcal/h ÷ 0,860
Kcal/h = Watt x 0,860

IDRAULICO
HYDRAULIC 

DIMENSIONI
DIMENSIONS

RESA
OUTPUT

RESA
CROMO
OUTPUT
CHROME

CAPACITÀ
CAPACITY

PESO
WEIGHT

COLORE
COLOUR

CROMO
CHROME

ART.	L	H	Z1	Z2	W	W	Lt	Kg	€	€
SNAKE ONE	500	1730	1700	410	670	540	11,5	15,5	1558,00	2600,00